

# COASTAL LIVING PRODUCTS

CREATE YOUR OUTDOOR OASIS



COASTAL  
LIVING  
PRODUCTS



# COASTAL LIVING PRODUCTS

## VINYL RAILING HAS IT ALL

Combining striking good looks, easy installation, and affordable price points, Coastal Living Products appeals to homeowners and professionals alike.

Our vinyl railing comes in a variety of sizes, heights and design configurations making it easy to achieve the look you want.

Coastal Living Products Rail Kits include everything you need for quick and easy installation, including all fasteners and brackets.

The low-maintenance PVC vinyl construction also provides peace-of-mind with aluminum-reinforced strength and durability that meets national, residential, and commercial building codes.

Coastal Living Products Railing Kits are made right here in the U.S.A. and our high quality workmanship is backed by a lifetime transferable warranty.



**COASTAL LIVING PRODUCTS RAILING IS ICC ESR-5074 APPROVED**







# VINYL RAILING

## TOP RAIL OPTIONS

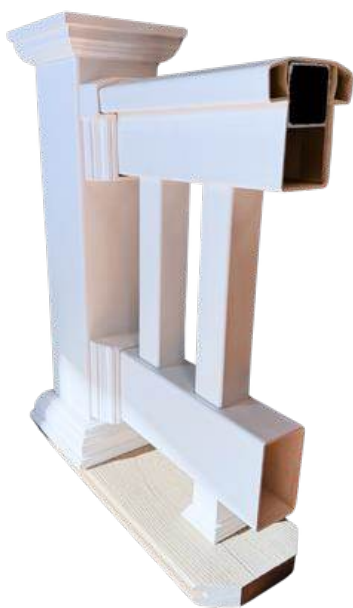

**Traditional**



**Contemporary**



**Drink Rail**



**Shore "T"**



# TRADITIONAL

**Heights: 36" or 42"** \*42" only available in 6' or 8' sections

**Widths - Level: 4', 5', 6', 8' or 10'**

**Widths - Stair: 6' or 8'**

**Top Rail Profile: 3 1/2" x 3 1/2" T-Rail**

**Colors:**   

**Baluster Options:**



**1 1/2" SQUARE  
BALUSTER**

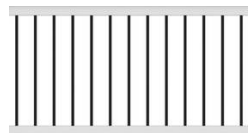

**3/4" BLACK  
ROUND OR SQUARE  
ALUMINUM BALUSTER**



**COLONIAL  
BALUSTER**



**1/4" GLASS  
BALUSTER**



**1/4" GLASS PANEL**



SKU: VRCLTSQLW6

## Standard Rail Kit Includes:

**3 1/2" x 3 1/2" Top T-Rail**

**2" x 3 1/2" Bottom Rail**

**Aluminum "P-Channel" Reinforcement (Top Rail)**

**Selection of Balusters**

**Adjustable Foot Block**

**Single or Double Aluminum  
Reinforcements Available**





# CONTEMPORARY

**Heights: 36" or 42"** \*42" only available in 6' or 8' sections

**Widths - Level: 4', 5', 6', 8' or 10'**

**Widths - Stair: 6' or 8'**

**Top Rail Profile: 2" x 3 1/2" Rail**

**Colors:**  White  Tan  Khaki

**Baluster Options:**



**1 1/2" SQUARE  
BALUSTER**

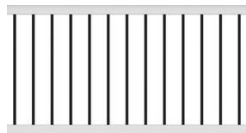

**3/4" BLACK  
ROUND OR SQUARE  
ALUMINUM BALUSTER**



**COLONIAL  
BALUSTER**



**1/4" GLASS  
BALUSTER**



**1/4" GLASS PANEL**

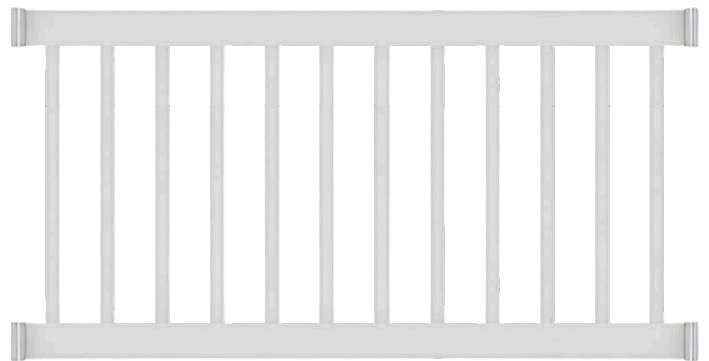

SKU: VRCLCSQLW6

## Standard Rail Kit Includes:

**2" x 3 1/2" Top and Bottom Rail**

**Aluminum "P-Channel" Reinforcement (Top Rail)**

**Selection of Balusters**

**Adjustable Foot Block**

**Single or Double Aluminum  
Reinforcements Available**



# DRINK RAIL

**Heights: 36" or 42"** \*42" only available in 6' or 8' sections

**Widths - Level: 4', 5', 6', 8' or 10'**

**Widths - Stair: 6' or 8'**

**Top Rail Profile: 2" x 3 1/2" Deck Top Rail**

**Only available in *WHITE***

**Baluster Options:**



**1 1/2" SQUARE  
BALUSTER**

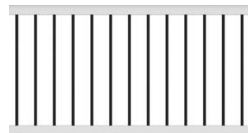

**3/4" BLACK  
ROUND OR SQUARE  
ALUMINUM BALUSTER**



**COLONIAL  
BALUSTER**



**1/4" GLASS  
BALUSTER**



**1/4" GLASS PANEL**



**SKU: VRCLDRSQLW6**

**Standard Rail Kit Includes:**

**2" x 3 1/2" Flanged Top Rail**

**2" x 3 1/2" Bottom Rail**

**Aluminum "P-Channel" Reinforcement (Top Rail)**

**Selection of Balusters**

**Adjustable Foot Block**

**Single or Double Aluminum  
Reinforcements Available**

**\*Top Deck Board Sold Separately**



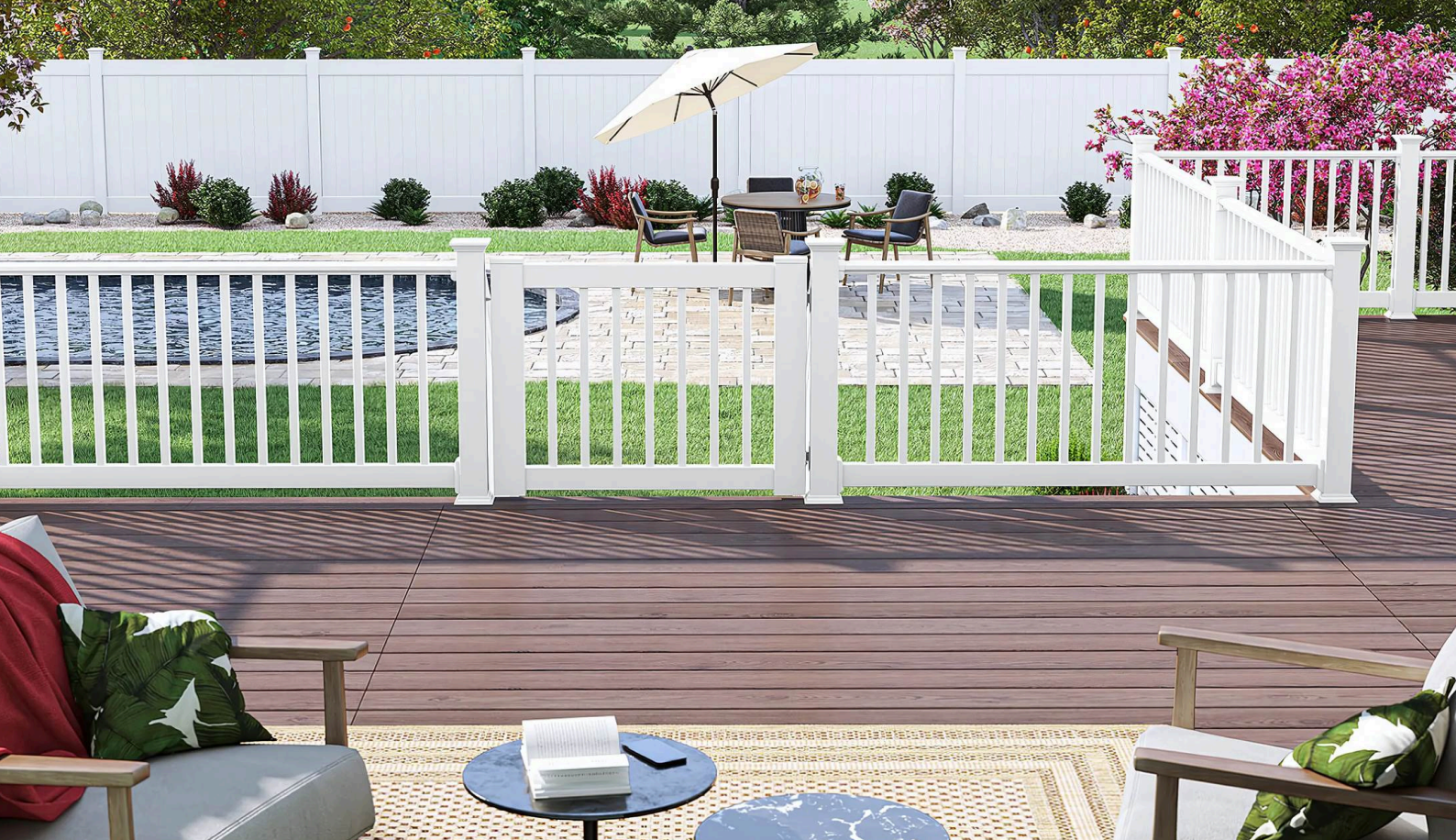

# SHORE "T"

**Height: 36"**

**Widths - Level: 5', 6', 8' or 10'**

**Widths - Stair: 6' or 8'**

**Top Rail Profile: 1 3/4" x 3" T-Rail**

**Only available in WHITE**

**Baluster Options:**



**1 3/8" SQUARE BALUSTER**

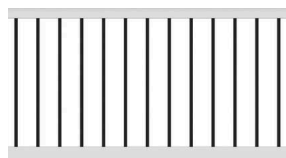

**3/4" BLACK ROUND OR  
SQUARE ALUMINUM  
BALUSTER**

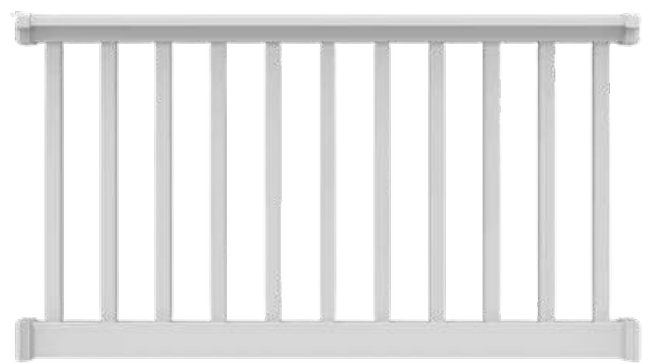

**SKU: VRCLSTSQLW6**

**Standard Rail Kit Includes:**

**1 3/4" x 3" Top T-Rail**

**2" x 3 1/2" Bottom Rail**

**Aluminum "Small-T" Reinforcement (Top Rail)**

**Selection of Balusters**

**Adjustable Foot Block**





## POST CAPS



**Internal**

4" SKU: VA4PCINW



**External**

4" SKU: VA4PCEXW  
5" SKU: VA5PCEXW



**New England**

4" SKU: VA4PCNEW  
5" SKU: VA5PCNEW  
6" SKU: VA6PCNEW



**Federation**

4" SKU: VA4PCFEDW  
5" SKU: VA5PCFEDW



**Dome**

4" SKU: VA4PCBALLW  
5" SKU: VA5PCBALLW



**Gothic**

4" SKU: VA4PCGOTHW  
5" SKU: VA5PCGOTHW



## SOLAR CAPS



**Solar**

5" SKU:  
VA5PCSOLARW



**Neptune**

4" SKU:  
VA4PCSOLARNEPTUNE



**Cape May**

4" SKU:  
VA4PCSOLARCAPEMAYW

## POST SKIRTS



**Classic**

4" SKU: VA4BASECLASW  
5" SKU: VA5BASECLASW



**New England**

4" SKU: VA4BASENEW  
5" SKU: VA5BASENEW  
6" SKU: VA6BASENEW



**2-Piece**

4" SKU: VA42BASEW

Select from a wide range of decorative post caps and solar lights to design a unique appearance that reflects your personal style





## POST SLEEVES



4" Post Sleeves: 39", 48", 54", 96", 108", **120"** or 144"

**4x4x10 SKU: VP4410W-B**

6" Post Sleeves: **120"** or 144"

**6x6x10 SKU: VP6610W-B**

## POST WRAPS

4 Piece Adjustable post wraps available in 4" and 6"

4" Wrap fits 3 1/4" - 4 3/8" Square Posts

**SKU: VAPSTWRAP4410W-B**

6" Wrap fits 5" - 5 13/16" Square Posts

**SKU: VAPSTWRAP6610W-B**

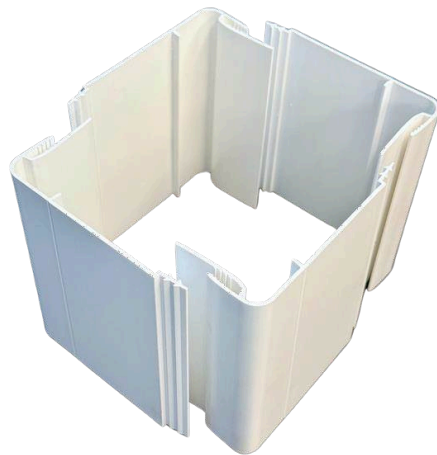

## POST MOUNTS

Post Mount Angle Wizard

**4" SKU: RPMAW436**







# ADA HANDRAILS

## Typical ADA Railing Installation

### Components:

- 1** 8' or 16' ADA Handrail w/ Aluminum Insert  
SKU: RADA1128WA
- 2** 6" Straight Joiner  
SKU: RADACONN
- 3** 4" Inside/Outside Corner  
SKU: RADA90INOUTCW
- 4** Straight End Wall Bracket  
SKU: RADASTALLW
- 5** Inside Corner Bracket  
SKU: RADA61CW
- 6** End Cap  
SKU: RADAECW
- 7** P-Loop Return  
SKU: RADA180PRW
- 8** 6" Adjustable Joiner  
SKU: RADAESJW
- 9** 90° Quick Return Bracket  
SKU: RADA90W
- 10** Stand Off Bracket  
SKU: RADA3MBW

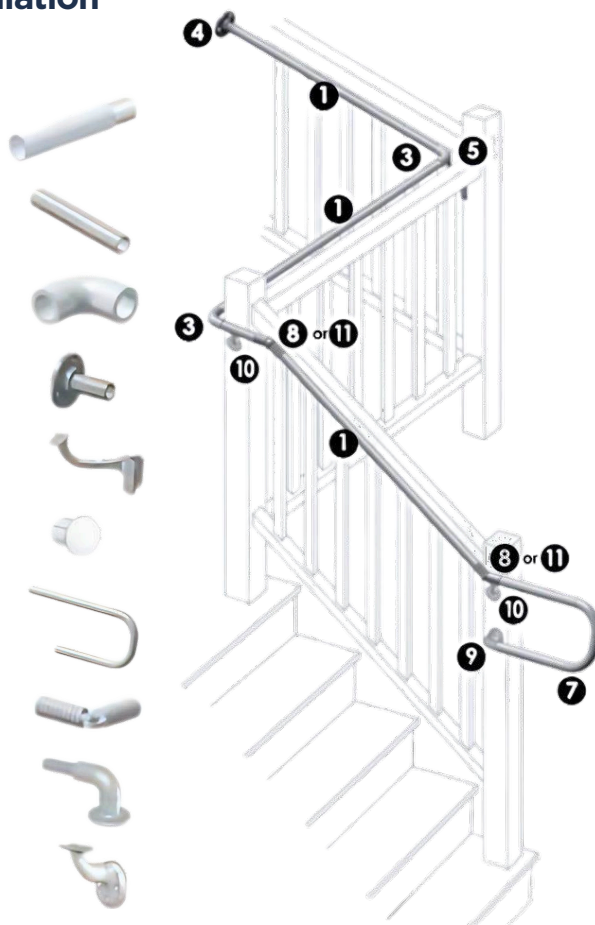

Coastal Living Products ADA Railing Systems are offered in complete kits and comply with the American Disability Act requirements for graspable hand rails.

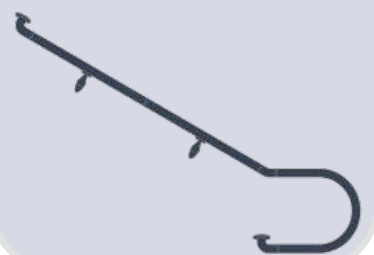





# ALUMINUM & CABLE RAILING

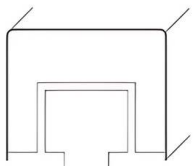

Alta Top Rail



## Profiles

- Alta
- Victorian

## Post Systems

- Baluster
- Horizontal and Vertical Cable
- Glass

## Panels

- Stair & Level
- 6' & 8'

## Available Colors

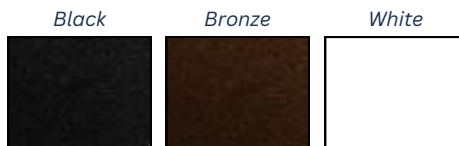

## Post Sizes

- 2"
- 3"

## Heights

- 36"
- 42"
- 48"

## Post Mounts

- Surface Mount
- Fascia Mount

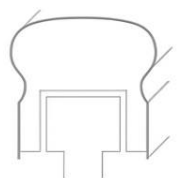

Victorian Top Rail







# COASTAL LIVING PRODUCTS

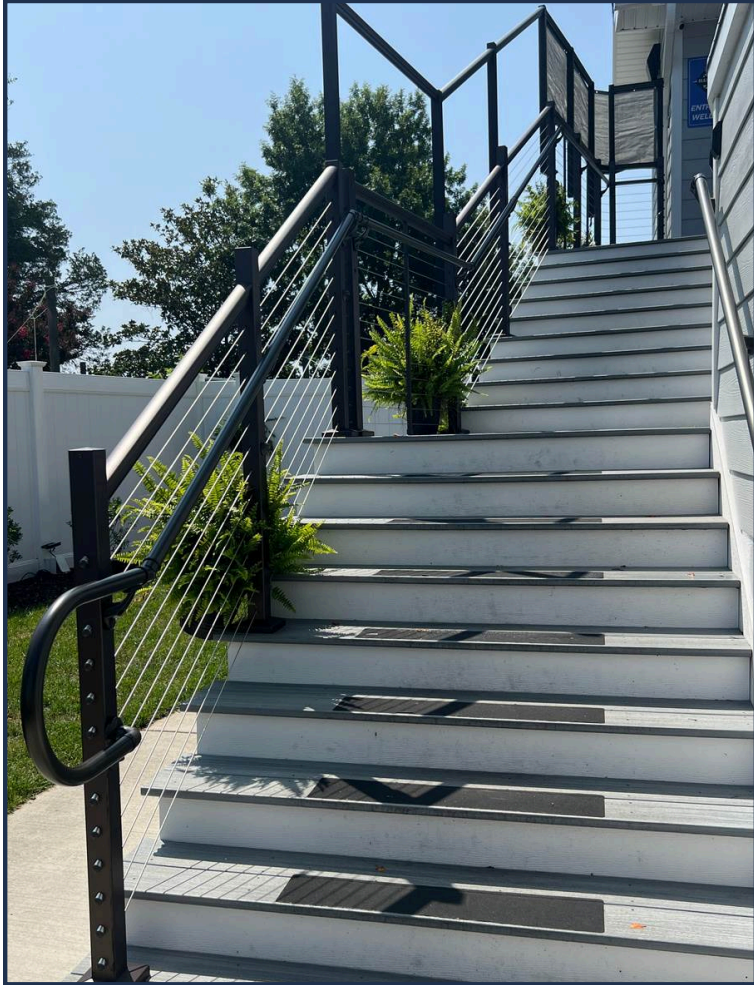

**Don't see what you looking for?**

**Give us a call, we do custom work as well!**

**SUPPLIED BY:**

**For more information, contact us today!**

(888) 401-8040

[Info@CoastalLivingProducts.com](mailto:Info@CoastalLivingProducts.com)

